

05 ABATIDORES Y CONGELADORES DE TEMPERATURA 3, 5, 7 NIVELES

BLAST CHILLERS AND FREEZERS 3, 5, 7 LEVELS

05 Abatidores

EXTERIOR

- Acero inox AISI 304 18/10

INTERIOR

- Acero inox AISI 304 18/10
- Desagüe interior
- Fondo embutido con amplios radios
- Estructura porta-bandejas (GN1/1 - 60x40)
- Marcos puerta calefactor para evitar acumulación de hielo

AISLAMIENTO

- Poliuretano inyectado alta presión libre de CFC's densidad 40 kg/m³, bajo GWP y cero efecto ODP

PUERTAS

- Contrapuerta embutida
- Bultete de triple cámara fácilmente sustituible
- Puertas con tirador integrado
- Bisagra pivotante con bloqueo de apertura

PATAS

- Patas en Acero Inox regulables en altura

REFRIGERACIÓN

- Sistema de condensación ventilada
- Evaporadores tratados anticorrosion 100% Poliéster
- Desescarche manual durante ciclos y automático en conservación
- Conservación en cámara finalizado el ciclo
- Abatimiento: de +90°C a +3°C en menos de 90 min
- Congelación rápida: de +90°C a -18°C en menos de 270 min

CONTROL DIGITAL

- Cuadro de mandos táctil con pantalla gráfica de fácil lectura y menú informativo
- Programa previene la formación escarcha en el producto
- Posibilidad de personalizar hasta 99 programas
- Conexión USB

EXTERIOR

- AISI 304 18/10 stainless steel

INTERIOR

- AISI 304 18/10 stainless steel
- Internal drain
- Sealed interior floors and rounded cabinet corners
- Tray Racks (GN1/1 - 60x40)
- Heated door frame to avoid accumulation of ice

INSULATION

- Free CFC's high density (40kg/m³) polyurethane insulation with low GWP & zero ODP effect

DOORS

- Stamped rear door
- Easy removal triple chamber gasket
- Integrated andel doors
- Self closing doors with stay open feature.

LEGS

- Stainless steel adjustable legs

REFRIGERATION

- Forced air refrigeration system
- Evaporator coil coated with anti-corrosion material 100% Polyester
- Manual defrost during cycles and automatic defrost during maintenance
- Temp Maintenance inside when cycle is finished
- Blast Chilling: de +90°C a +3°C en menos de 90 min
- Blast freezing: de +90°C a -18°C en menos de 270 min

DIGITAL CONTROL

- Touch control panel with an easy to read screen and menú
- A control that prevents frost from forming on the product.
- It has the possibility to personalize and memorise 99 programmes
- USB connection

ENTRADA BANDEJA · TRAYS ENTRY

1S  GN 1/1 600x400

1L  GN 1/1 600x400

MODELOS MODELS	Dimensiones Dimensions LxWxH (mm)	Tensión/Frecuencia Electrical (V/Hz)	Nº Bandejas (Opcional) Trays (Optional)	Distancia entre bandejas Distance between trays	Rendimiento (Kg) Abatimiento congelación	Compresor Compressor (HP)	Evaporación Evaporation	Control Control	Refrigerante Refrigerant
ABT3 1S	721x711x536	220/50	3 GN 1/1	65	10/5	1/2	Forzada Forced	Digital	R 404 A
ABT5 1L	837x836x925	220/50	5 GN 1/1 600x400	65	20/12	1	Forzada Forced	Digital	R 404 A
ABT7 1L	837x836x1106	220/50	7 GN 1/1 600x400	65	30/18	1 1/4	Forzada Forced	Digital	R 404 A
ABT7 1M	1468x700x850	220/50	7 GN 1/1	65	30/18	1 1/4	Forzada Forced	Digital	R 404 A

Características técnicas y constructivas sujetas a variación sin previo aviso / We reserve the right to change specifications without prior notice.

ABATIDORES Y CONGELADORES DE TEMPERATURA 3, 5, 7 NIVELES
BLAST CHILLERS AND FREEZERS 3, 5, 7 LEVELS



ABT3 1S



ABT5 1L



ABT7 1L



ABT7 1M
 [Compatible con GN 1/1 / Compatible with GN 1/1]

05 Abatidores

OPCIONAL / OPTIONAL

- Esterilizador / Sterilizer **(407X26)**
- Bandejas inox GN 1/1 / Stainless GN 1/1 trays **(501x23)**
- Bandeja 60x40 / 60x40 trays **(A850P41)**

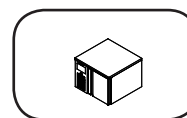

ABT3 1S

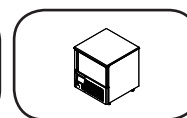

ABT5 1L

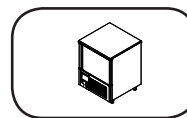

ABT7 1L

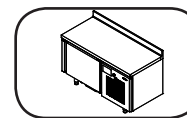

ABT7 1M

05 ABATIDORES Y CONGELADORES DE TEMPERATURA 10, 14 NIVELES

BLAST CHILLERS AND FREEZERS 10, 14 LEVELS

05 Abatidores



ABT 10 1L







OPCIONAL / OPTIONAL

- Esterilizador / Sterilizer **(407X26)**
- Bandejas inox GN 1/1 / Stainless GN 1/1 trays **(501x23)**
- Bandejas inox GN 2/1 / Stainless GN 2/1 trays **(501x24)**
- Bandeja 60x40 / 60x40 trays **(A850P41)**
- Conexión 220v/lph/50Hz / 220v/lph/50Hz connection (ABT 10, 14)

ENTRADA BANDEJA · TRAYS ENTRY

2S  GN 2/1 800x600

1L  GN 1/1 600x400

MODELOS MODELS										
	Dimensiones Dimensions LxHxP (mm)	Tensión/Frecuencia Electrical V/Hz	Nº Bandejas (Opcional) Trays (Optional)	Distancia entre bandejas Distance between trays	Rendimiento (Kg) Abatimiento congelación	Compresor Compressor (HP)	Evaporación Evaporation	Control Control	Refrigerante Refrigerant	
ABT10 1L	837x836x1760	3N 380/50	10 GN 1/1 600x400	65	40/25	2	Forzada Forced	Digital	R 404 A	
ABT14 1L	837x836x1760	3N 380/50	14 GN 1/1 600x400	65	50/30	2 1/2	Forzada Forced	Digital	R 404 A	
ABT10 2S	1072x1071x1950	3N 380/50	10 GN 2/1 800x600	75	80/50	4	Forzada Forced	Digital	R 404 A	

Características técnicas y constructivas sujetas a variación sin previo aviso / We reserve the right to change specifications without prior notice.

ABATIDORES Y CONGELADORES DE TEMPERATURA 10, 14 NIVELES
BLAST CHILLERS AND FREEZERS 10, 14 LEVELS



ABT14 1L



ABT10 2S

05 Abatidores

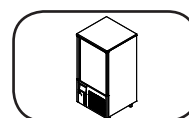
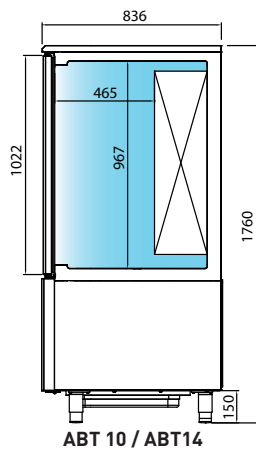

ABT10 1L

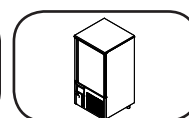

ABT14 1L

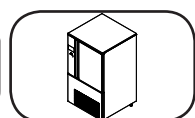

ABT10 2S

05 ABATIDORES Y CONGELADORES DE TEMPERATURA 20 NIVELES

BLAST CHILLERS AND FREEZERS 20 LEVELS

ENTRADA CARRO · CAR ENTRY

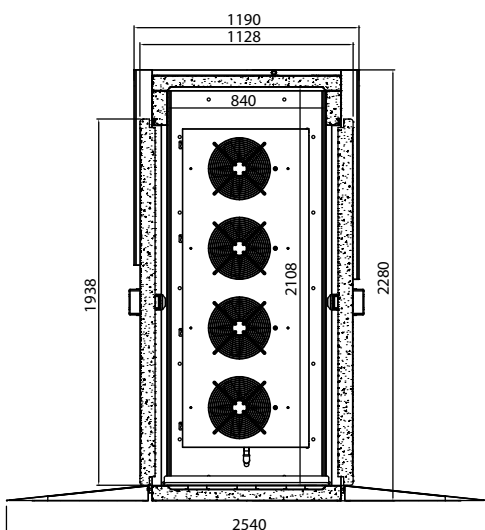
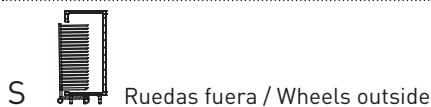
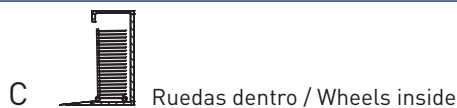







CBGN 2011 / CBGN 2021



05 Abatidores

OPCIONAL / OPTIONAL

- Rampa / Ramp (**RAMABT21**)
- Carro [455x635x1787] GN 1/1 / Car [455x635x1787] GN 1/1 (**CBGN2011**)
- Carro [660x755x1787] GN 2/1 / Car [660x755x1787] GN 2/1 (**CBGN2021**)
- Carro [530x705x1787] 600x400 mm / Car [530x705x1787] 600x400 mm (**CBE20**)

MODELOS MODELS									
	Dimensiones Dimensions LxWxH (mm)	Tensión/Frecuencia Electrical (V/Hz)	Carro Cars	Rendimiento (Kg) Abatimiento congelación	Potencia frigorífica (-10°C / -25°C)	Evaporación Evaporation	Control Control	Refrigerante Refrigerant	
ABT20 1C	1200x1095x2280	3N 380/50	20 GN 1/1	110 / 60	10073 / 5387	Forzada Forced	Digital	R 404 A	
ABT20 2C	1400x1295x2280	3N 380/50	20 GN 2/1	110 / 60	10073 / 5387	Forzada Forced	Digital	R 404 A	
*ABT20 1S	1200x1095x2280	3N 380/50	20 GN 1/1	110 / 60	10073 / 5387	Forzada Forced	Digital	R 404 A	
*ABT20 2S	1400x1295x2280	3N 380/50	20 GN 2/1	110 / 60	10073 / 5387	Forzada Forced	Digital	R 404 A	
ABT20 1P	1200x1180x2280	3N 380/50	20 GN 1/1	110 / 60	10073 / 5387	Forzada Forced	Digital	R 404 A	
ABT20 2P	1400x1390x2280	3N 380/50	20 GN 2/1	110 / 60	10073 / 5387	Forzada Forced	Digital	R 404 A	
ABT20 2CP	1400x1295x2280	3N 380/50	20 GN 2/1	230 / 130	20869 / 11411	Forzada Forced	Digital	R 404 A	
ABT20 2SP	1400x1295x2280	3N 380/50	20 GN 2/1	230 / 130	20869 / 11411	Forzada Forced	Digital	R 404 A	
ABT20 2PP	1400x1390x2280	3N 380/50	20 GN 2/1	230 / 130	20869 / 11411	Forzada Forced	Digital	R 404 A	

Características técnicas y constructivas sujetas a variación sin previo aviso / We reserve the right to change specifications without prior notice.

*Compatible con 

ABATIDORES Y CONGELADORES DE TEMPERATURA 20 NIVELES
BLAST CHILLERS AND FREEZERS 20 LEVELS



Rampa opcional / Ramp optional

ABT20 2P

05 Abatidores

- | | | | | |
|-----------------|------------------|------------------|------------------|-----------------|
| | | | | |
| ABT20 1C | ABT20 2C | ABT20 1S | ABT20 2S | ABT20 1P |
| | | | | |
| ABT20 2P | ABT20 2CP | ABT20 2SP | ABT20 2PP | |

05 ABATIDORES Y CONGELADORES DE TEMPERATURA 20 NIVELES DOBLES

DOUBLES BLAST CHILLERS AND FREEZERS 20 LEVELS

ENTRADA CARRO · CAR ENTRY

C  Ruedas dentro / Wheels inside

CP/SP/PP  Potenciados / Power full

S  Ruedas fuera / Wheels outside



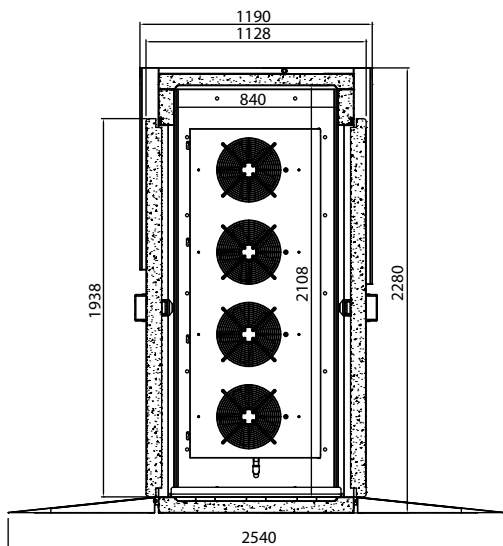





P  Pasante / Pass-throw



CBGN 2011 / CBGN 2021

OPCIONAL / OPTIONAL

- Rampa / Ramp (**RAMABT21**)
- Carro (660x755x1787) GN 2/1 / Car (660x755x1787) GN 2/1 (**CBGN2021**)
- Carro (530x705x1787) 600x400 mm / Car (530x705x1787) 600x400 mm (**CBE20**)

MODELOS MODELS									
	Dimensiones Dimensions LxAnxH (mm)	Tensión/Frecuencia Electrical (V/Hz)	Carro Cars	Rendimiento (Kg) Abatimiento congelación	Potencia frigorífica (-10°C / -25°C)	Evaporación Evaporation	Control Control	Refrigerante Refrigerant	
ABT20 3C	1200x2095x2280	3N 380/50	3x20 GN 1/1	230 / 130	20869 / 11411	Forzada Forced	Digital	R 404 A	
ABT20 4C	1400x2095x2280	3N 380/50	3x20 GN 1/1	230 / 130	20869 / 11411	Forzada Forced	Digital	R 404 A	
ABT20 3P	1200x2180x2280	3N 380/50	3x20 GN 1/1	230 / 130	20869 / 11411	Forzada Forced	Digital	R 404 A	
ABT20 4P	1400x2180x2280	3N 380/50	3x20 GN 1/1	230 / 130	20869 / 11411	Forzada Forced	Digital	R 404 A	
ABT203 CP	1200x2095x2280	3N 380/50	3x20 GN 1/1	460 / 260	41738 / 22822	Forzada Forced	Digital	R 404 A	
ABT204 CP	1400x2095x2280	3N 380/50	3x20 GN 1/1	460 / 260	41738 / 22822	Forzada Forced	Digital	R 404 A	
ABT203 PP	1200x2180x2280	3N 380/50	3x20 GN 1/1	460 / 260	41738 / 22822	Forzada Forced	Digital	R 404 A	
ABT204 PP	1400x2180x2280	3N 380/50	3x20 GN 1/1	460 / 260	41738 / 22822	Forzada Forced	Digital	R 404 A	

Características técnicas y constructivas sujetas a variación sin previo aviso / We reserve the right to change specifications without prior notice.

ABATIDORES Y CONGELADORES DE TEMPERATURA 20 NIVELES DOBLES
DOUBLES BLAST CHILLERS AND FREEZERS 20 LEVELS



**NUEVO
NEW**



ABT20 4P

05 Abatidores

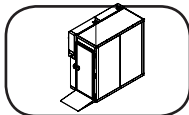

ABT20 3C

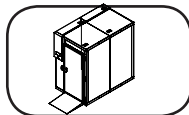

ABT20 4C

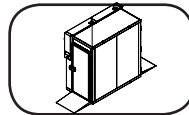

ABT20 3P

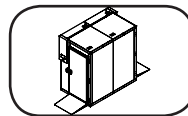

ABT20 4P

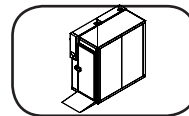

ABT20 3CP

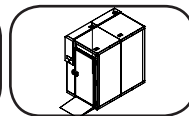

ABT20 4CP

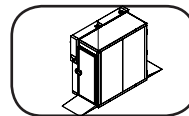

ABT20 3PP

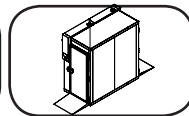

ABT20 4PP