

07 VITRINA EXPOSITORA MODULAR FRÍO VENTILADO SERIE EUROPA

REFRIGERATED MODULAR DISPLAY CASE EUROPA SERIES

07 V. expositoras

EXTERIOR

- Chapa de acero plastificada
- Encimera de trabajo en acero inox AISI 304 18/10
- Cristal curvo securizado elevable
- Bancada en acero esmaltado
- Claro de puerta de acceso media reserva 425x225
- Decoracion en DM lacado con iluminación LED

INTERIOR

- Plano de exposición esmaltado
- Iluminación LED plano de exposición tipo Grolux
- Línea Modular

AISLAMIENTO

- Poliuretano inyectado alta presión libre de CFC´s densidad 40 kg/m³, bajo GWP y cero efecto ODP

REFRIGERACIÓN

- Sistema de condensación ventilada
- Bandeja evaporativa doble en acero inoxidable primera por gas caliente y segunda con resistencia eléctrica
- Control temperatura final del desescarche
- Clase climática 4

EXTERIOR

- Laminated steel plate
- AISI 304 18/10 stainless steel worktop
- Lift-up curved tempered security glass system
- Enamelled steel base
- Storage door opening 425x225
- DM lacqued decoration with LED lighting

INTERIOR

- Enameled exhibition steel surface
- Grolux type for exhibition area
- Modulaire Line

INSULATION

- Free CFC's high density (40kg/m³) polyurethane insulation with low GWP & zero ODP effect

REFRIGERATION

- Forced air refrigeration system
- Stainless steel evaporative double trays first by host gas second by electrical resistance
- Control of the final defrost temperature
- Climatic class 4

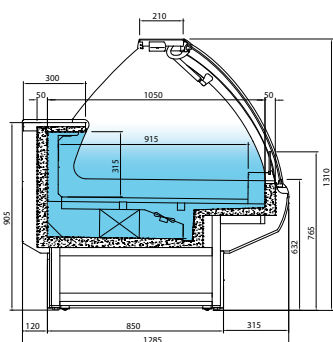

(S) SIN RESERVA
WITHOUT STORAGE

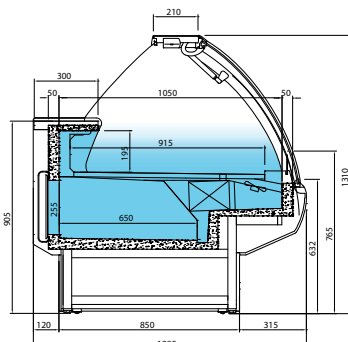

(R) CON RESERVA
WITH STORAGE



(R) RESERVA
STORAGE

* Modelos para conectar a unidad remota / Remote condusing unit

MODELOS MODELS	Dimensiones sin costados Dimensions without sides LxExH (mm)	Costados Sides (2)l(mm)	Potencia Power (W)	Electrica Electrical (V/Hz)	Capacidad Capacity (L)	Puertas Doors	Superficie exposición (m ²)	Compresor Compressor (HP)	Consumo Consumption (kWh/24h)	Evaporación Evaporation	Régimen T ^{RA} 30°C/55% H.R	Potencia frigorífica Refrigerating power (W @ -10°C)	Desescarche Defrost	Control Control	Refrigerante Refrigerant
VEU 9 R/S	938x1285x1310	40+40	755	220/50	159 (R)	1 (R)	0,86	1/2	10,6	Forzada Forced	0°C/+6°C	676	Automático Automatic	Digital	R 404 A
VEU 12 R/S	1250x1285x1310	40+40	1015	220/50	213 (R)	2 (R)	1,14	5/8	14,2	Forzada Forced	0°C/+6°C	1096	Automático Automatic	Digital	R 404 A
VEU 15 R/S	1562x1285x1310	40+40	1070	220/50	266 (R)	2 (R)	1,43	3/4	15,0	Forzada Forced	0°C/+6°C	1315	Automático Automatic	Digital	R 404 A
VEU 18 R/S	1875x1285x1310	40+40	1310	220/50	319 (R)	3 (R)	1,72	1	18,3	Forzada Forced	0°C/+6°C	1506	Automático Automatic	Digital	R 404 A
VEU 25 R/S	2500x1285x1310	40+40	1585	220/50	425 (R)	4 (R)	2,29	1+1/6	22,2	Forzada Forced	0°C/+6°C	2009	Automático Automatic	Digital	R 404 A
* VEU 31 R/S	3125x1285x1310	40+40	310	220/50	531 (R)	5 (R)	2,86	-	4,3	Forzada Forced	0°C/+6°C	2600	Automático Automatic	Digital	R 404 A
* VEU 37 R/S	3750x1285x1310	40+40	370	220/50	638 (R)	6 (R)	3,43	-	5,2	Forzada Forced	0°C/+6°C	3000	Automático Automatic	Digital	R 404 A

Características técnicas y constructivas sujetas a variación sin previo aviso / We reserve the right to change specifications without prior notice.

VITRINA EXPOSITORA MODULAR FRÍO VENTILADO SERIE EUROPA
 REFRIGERATED MODULAR DISPLAY CASE EUROPA SERIES



VEU 18 R

* Incremento por unidad cristal calefactado/Heater frontal glass por unit increase

OPCIONAL / OPTIONAL

MODELOS MODELS	Puertas correderas traseras Rear sliding doors	Cortinas nocturnas Night curtains	Doble plano Double surface
VEU 9	(PUEVEU9CT)	(CCNV9)	(DPEXVEU9S)
VEU 12	(PUEVEU12CT)	(CCNV12)	(DPEXVEU12S)
VEU 15	(PUEVEU15CT)	(CCNV15)	(DPEXVEU15S)
VEU 18	(PUEVEU18CT)	(CCNV18)	(DPEXVEU18S)
VEU 25	(PUEVEU25CT)	(CCNV25)	(DPEXVEU25S)
VEU 31	(PUEVEU31CT)	(CCNV31)	(DPEXVEU31S)
VEU 37	(PUEVEU37CT)	(CCNV37)	(DPEXVEU37S)



07 V. expositoras

07 VITRINA EXPOSITORA MODULAR FRÍO VENTILADO SERIE EUROPA

REFRIGERATED MODULAR DISPLAY CASE EUROPE SERIES

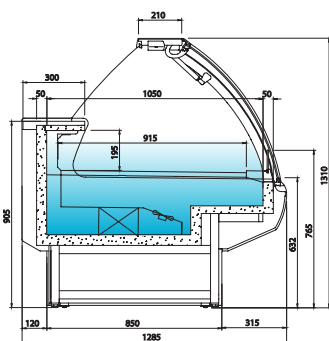

VEU-R

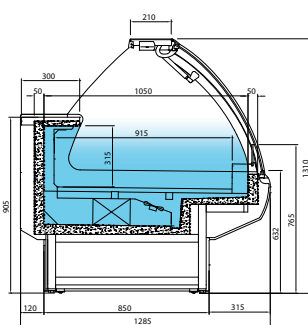

VEU-S

07 V. expositoras

OPCIONAL / OPTIONAL

MODELOS MODELS	Puertas correderas traseras Rear sliding doors	Doble plano Double surface	Plano expo Acero Inox Stainless steel exhibition area
VEU 90 AA	(PUEVEU90AACT)	(DPEXVEU90AAS)	(DPEXVEU90AAS)
VEU 45 AA	(PUEVEU45AACT)	(DPEXVEU45AAS)	(DPEXVEU45AAS)
VEU 90 AC	(PUEVEU90ACCT)	(DPEXVEU90ACS)	(DPEXVEU90ACS)
VEU 45 AC	(PUEVEU45ACCT)	(DPEXVEU45ACS)	(DPEXVEU45ACS)

MODELOS MODELS	Dimensiones sin costados Dimensions without sides LxExH (mm)	Costados Sides (2)l(mm)	Potencia Power (W)	Electrica Electrical (V/Hz)	Capacidad Capacity (L)	Puertas Doors	Superficie exposición (m ²)	Compresor Compressor (HP)	Consumo Consumption (kWh/24h)	Evaporación Evaporation	Régimen T ^{RA} 30°C/60% H.R	Potencia frigorífica Refrigerating power (W a -10°C)	Desescarche Defrost	Control Control	Refrigerante Refrigerant
VEU 90 AA S/R	1326x1285x1310	40+40	1025	220/50	-	-	1,10	5/8	14,4	Forzada Forced	0°C/+6°C	817	Automático Automatic	Digital	R 404 A
VEU 45 AA SN/RN	1108x1285x1310	40+40	350	220/50	-	-	0,60		0,5	Forzada Forced	0°C/+6°C		Automático Automatic	Digital	R 404 A
VEU 90 AC S/R	1887x1285x1310	40+40	1110	220/50	-	-	1,85	3/4	15,5	Forzada Forced	0°C/+6°C	1315	Automático Automatic	Digital	R 404 A
VEU 45 AC S/R	1285x1150x1310	40+40	780	220/50	-	-	0,92	1/2	10,9	Forzada Forced	0°C/+6°C	817	Automático Automatic	Digital	R 404 A

Características técnicas y constructivas sujetas a variación sin previo aviso / We reserve the right to change specifications without prior notice.

VITRINA EXPOSITORA MODULAR FRÍO VENTILADO SERIE EUROPA
 REFRIGERATED MODULAR DISPLAY CASE EUROPE SERIES

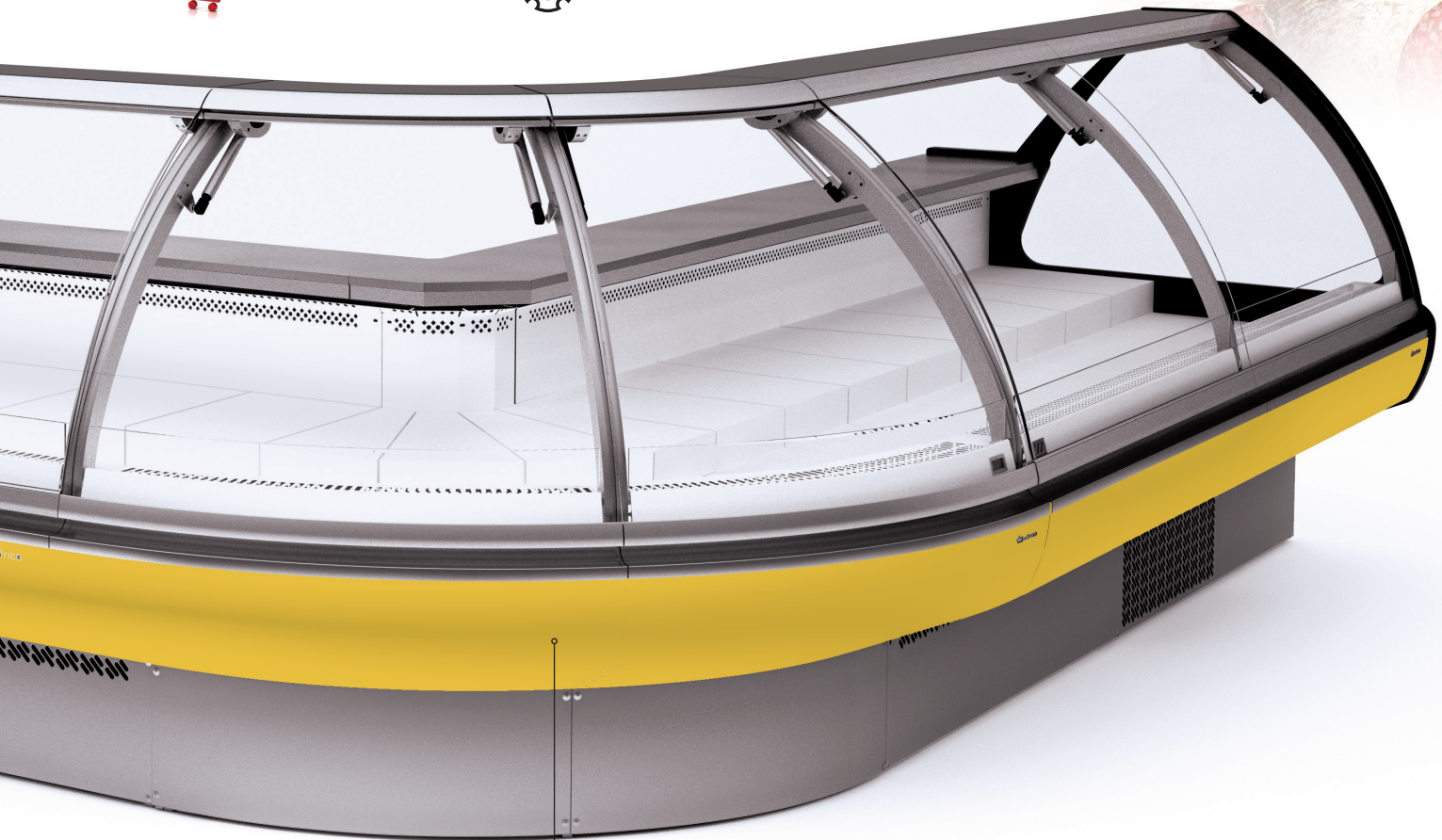

VEU 90 AA S

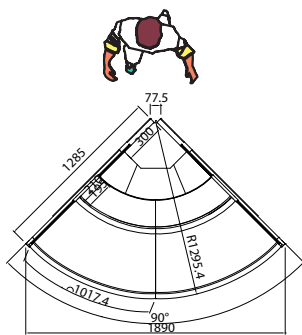

VEU 90 AA R

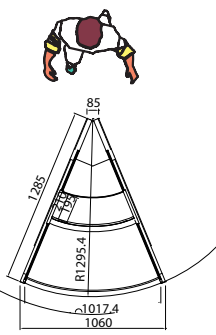

VEU 45 AA RN

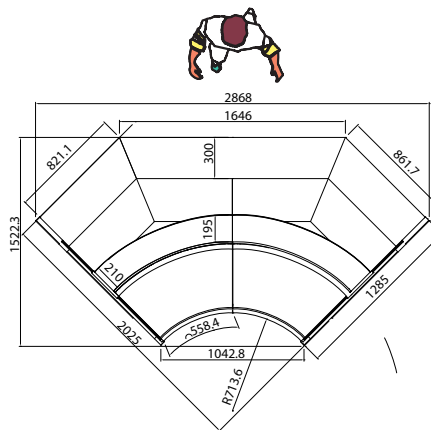

VEU 90 AC R

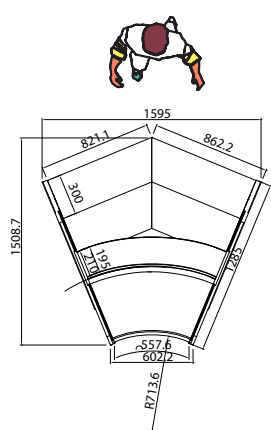

VEU 45 AC R

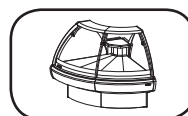

VEU 90 AA R

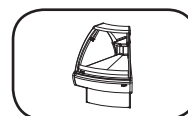

VEU 45 AA RN

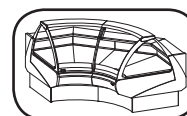

VEU 90 AC R



VEU 45 AC R

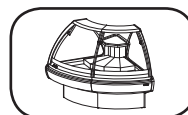

VEU 90 AA S



VEU 45 AA SN

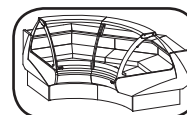

VEU 90 AC S

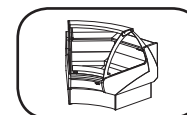

VEU 45 AC S

07 V. expositoras

07 VITRINA EXPOSITORA MODULAR FRÍO VENTILADO CON RESERVA SERIE EUROPA

REFRIGERATED WITH STORAGE MODULAR DISPLAY CASE EUROPE SERIES



VEU 9 RCP

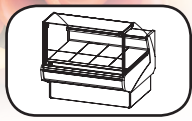

VEU 12 RCP

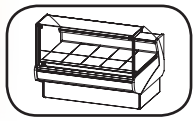

VEU 15 RCP

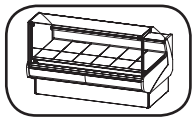

VEU 18 RCP

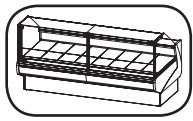

VEU 25 RCP

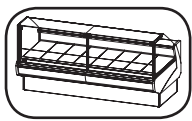

VEU 31 RCP

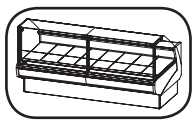

VEU 37 RCP

NUEVO
NEW



07 V. expositoras

- Con reserva / With storage
- Vidrio recto elevable / Lift-up frontal glass

MODELOS MODELS	→ ↗ ↑ ↘	⚡	📦	📱	🖨️	🛒	💧	🌡️	❄️	🔧	🌡️	🧊	🔧	🌡️	
	Dimensiones sin costados Dimensions without sides LxPxH (mm)	Costados Sides (2)(mm)	Potencia Power (W)	Electrica Electrical (V/Hz)	Capacidad Capacity (L)	Puertas Doors	Superficie exposición (m ²)	Compresor Compressor (HP)	Consumo Consumption (kWh/24h)	Evaporación Evaporation	Régimen T ^{PA} 30°C/55% H.R	Potencia frigorífica Refrigerating power (W a -10°C)	Desescarche Defrost	Control Control	Refrigerante Refrigerant
VEU 9 RCP	938x1285x1310	40+40	755	220/50	159	1	0,86	1/2	10,6	Forzada Forced	0°C/+6°C	676	Automático Automatic	Digital	R 404 A
VEU 12 RCP	1250x1285x1310	40+40	1015	220/50	213	2	1,14	5/8	14,2	Forzada Forced	0°C/+6°C	1096	Automático Automatic	Digital	R 404 A
VEU 15 RCP	1562x1285x1310	40+40	1070	220/50	266	2	1,43	3/4	15,0	Forzada Forced	0°C/+6°C	1315	Automático Automatic	Digital	R 404 A
VEU 18 RCP	1875x1285x1310	40+40	1310	220/50	319	3	1,72	1	18,3	Forzada Forced	0°C/+6°C	1506	Automático Automatic	Digital	R 404 A
VEU 25 RCP	2500x1285x1310	40+40	1585	220/50	425	4	2,29	1+1/6	22,2	Forzada Forced	0°C/+6°C	2009	Automático Automatic	Digital	R 404 A
VEU 31 RCP GR	3125x1285x1310	40+40	310	220/50	531	5	2,86	-	4,3	Forzada Forced	0°C/+6°C	2600	Automático Automatic	Digital	R 404 A
VEU 37 RCP GR	3750x1285x1310	40+40	370	220/50	638	6	3,43	-	5,2	Forzada Forced	0°C/+6°C	3000	Automático Automatic	Digital	R 404 A

Características técnicas y constructivas sujetas a variación sin previo aviso / We reserve the right to change specifications without prior notice.

VITRINA EXPOSITORA MODULAR FRÍO VENTILADO SIN RESERVA SERIE EUROPA
 REFRIGERATED WITHOUT STORAGE MODULAR DISPLAY CASE EUROPE SERIES



VEU 9 SCP

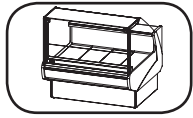

VEU 12 SCP

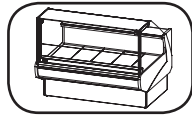

VEU 15 SCP

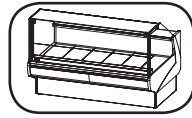

VEU 18 SCP

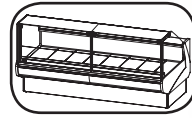

VEU 25 SCP

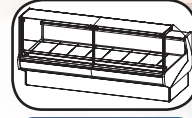

VEU 31 SCP

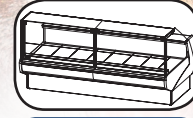

VEU 37 SCP

NUEVO
NEW

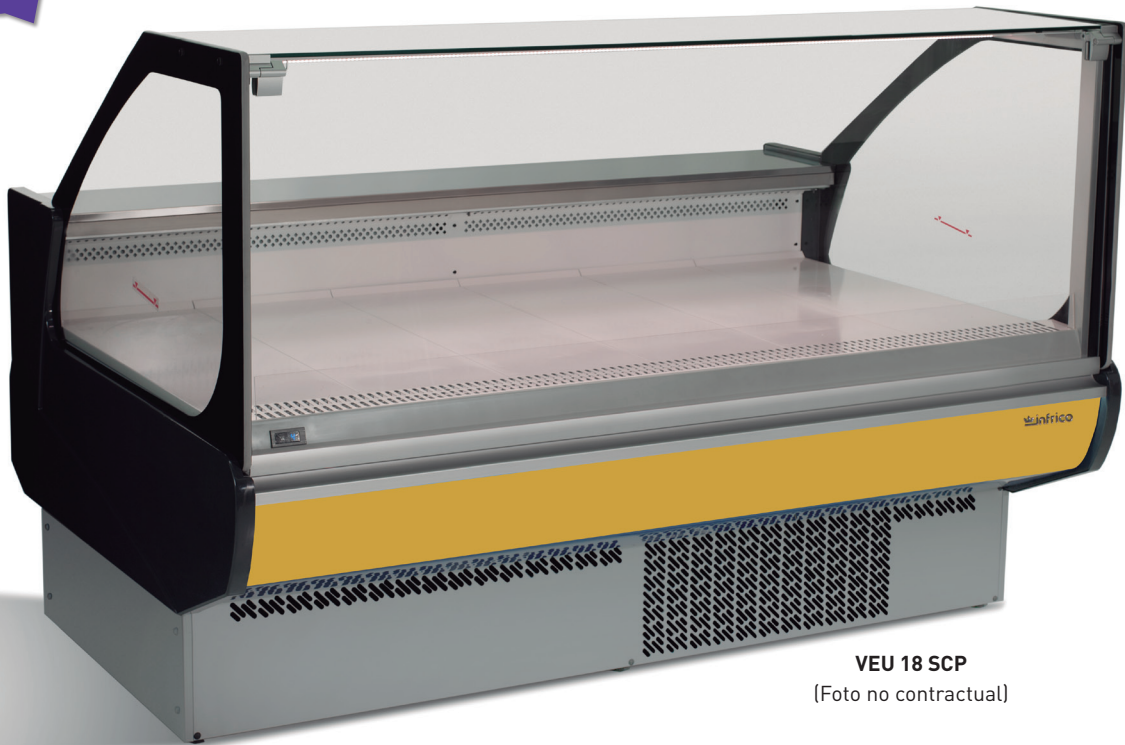

VEU 18 SCP
(Foto no contractual)

07 V. expositoras

- Sin reserva / Without storage
- Vidrio recto elevable / Lift-up frontal glass

MODELOS MODELS	→	↗	↑	⏻	⚡	📦	🚪	📏	🔧	🛒	💧	🌡️	❄️	🔌	🌡️	❄️
	Dimensiones sin costados Dimensions without sides LxFxH (mm)	Costados Sides (l/mm)	Potencia Power (W)	Electrica Electrical (V/Hz)	Capacidad Capacity (L)	Puertas Doors	Superficie exposición (m ²)	Compresor Compressor (HP)	Consumo Consumption (kWh/24h)	Evaporación Evaporation	Régimen T _{RA} 30°C/55% H.R	Potencia frigorífica Refrigerating power (W a -10°C)	Desescarche Defrost	Control Control	Refrigerante Refrigerant	
VEU 9 SCP	938x1285x1310	40+40	755	220/50	-	-	0,86	1/2	10,6	Forzada Forced	0°C/+6°C	676	Automático Automatic	Digital	R 404 A	
VEU 12 SCP	1250x1285x1310	40+40	1015	220/50	-	-	1,14	5/8	14,2	Forzada Forced	0°C/+6°C	1096	Automático Automatic	Digital	R 404 A	
VEU 15 SCP	1562x1285x1310	40+40	1070	220/50	-	-	1,43	3/4	15,0	Forzada Forced	0°C/+6°C	1315	Automático Automatic	Digital	R 404 A	
VEU 18 SCP	1875x1285x1310	40+40	1310	220/50	-	-	1,72	1	18,3	Forzada Forced	0°C/+6°C	1506	Automático Automatic	Digital	R 404 A	
VEU 25 SCP	2500x1285x1310	40+40	1585	220/50	-	-	2,29	1+1/6	22,2	Forzada Forced	0°C/+6°C	2009	Automático Automatic	Digital	R 404 A	
VEU 31 SCP GR	3125x1285x1310	40+40	310	220/50	-	-	2,86	-	4,3	Forzada Forced	0°C/+6°C	2600	Automático Automatic	Digital	R 404 A	
VEU 37 SCP GR	3750x1285x1310	40+40	370	220/50	-	-	3,43	-	5,2	Forzada Forced	0°C/+6°C	3000	Automático Automatic	Digital	R 404 A	

Características técnicas y constructivas sujetas a variación sin previo aviso / We reserve the right to change specifications without prior notice.

07 VITRINA EXPOSITORA MODULAR FRÍO VENTILADO AUTOSERVICIO SERIE EUROPA

REFRIGERATED MODULAR SELF SERVICE CASE EUROPE SERIES

EXTERIOR

- Chapa de acero plastificada
- Encimera de trabajo en acero inox AISI 304 18/10
- Bancada en acero esmaltado
- Decoracion en DM lacado con iluminación LED 

INTERIOR

- Plano de exposición en Acero esmaltado

AISLAMIENTO

- Poliuretano inyectado alta presión libre de CFC 's densidad 40 kg/m³, bajo GWP y cero efecto ODP

REFRIGERACIÓN

- Sistema de condensación ventilada
- Bandeja evaporativa doble en acero inoxidable primera por gas caliente y segunda con resistencia eléctrica
- Control temperatura final del desescarche
- Desescarche por gas caliente
- Cortina nocturna

EXTERIOR

- Laminated steel plate
- AISI 304 18/10 stainless steel worktop
- Enamelled steel base
- DM lacqued decoration with LED lighting 

INTERIOR

- Enameled exhibition steel surface

INSULATION

- Free CFC's high density [40kg/m³] polyurethane insulation with low GWP & zero ODP effect

REFRIGERATION

- Forced air refrigeration system
- Stainless steel evaporative double trays first by host gas second by electrical resistance
- Control of the final defrost temperature
- Hot gaz defrost
- Night curtain

NUEVO
NEW

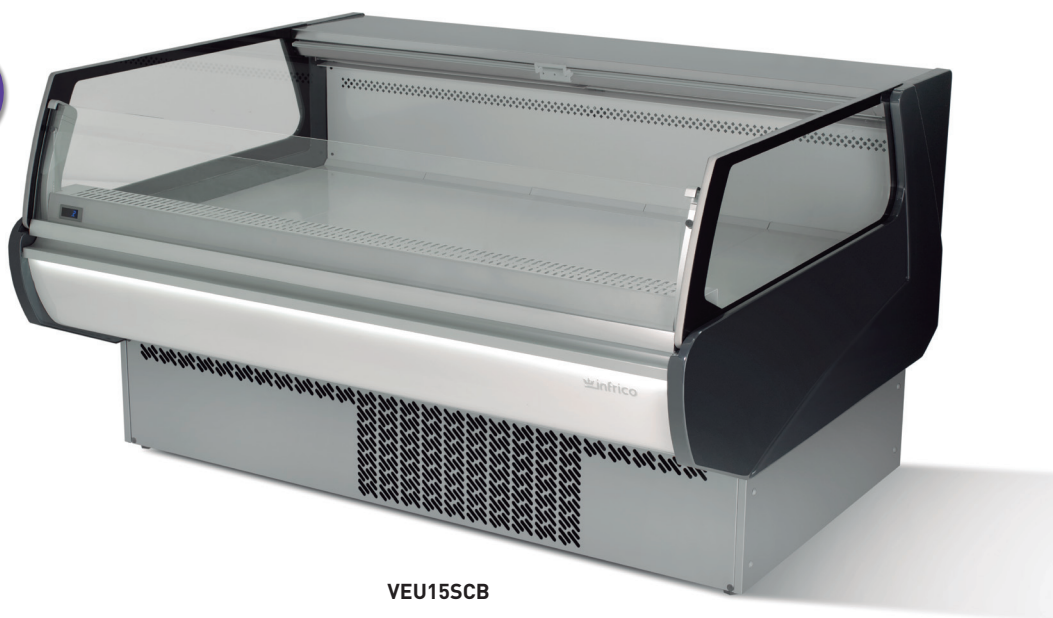

VEU15SCB

MODÈLES	→	↗	↑	⏻	⚡	⚠	📏	🔧	🛒	💧	🌡	📺	❄	🕒	🌡
	Dimensiones sin costados Dimensions without sides LxFxH (mm)	Costados Sides (2)(mm)	Potencia Power (W)	Electrica Electrical (V/Hz)	Capacidad Capacity (L)	Superficie exposición (m ²)	Compresor Compressor (HP)	Consumo Consumption (kWh/24h)	Evaporación Evaporation	Régimen T ^{int} 25°C/60% H.R	Desescarche Defrost	Potencia frigorífica Refrigerating power (W a -10°C)	Control Control	Refrigerante Refrigerant	
VEU 9 SCB	938x1285x905	40+40	755	220/50	-	0,86	1/2	10,6	Forzada Forced	2°C/+6°C	Automático Automatic	817	Digital	R 404 A	
VEU 12 SCB	1250x1285x905	40+40	1015	220/50	-	1,14	5/8	14,2	Forzada Forced	2°C/+6°C	Automático Automatic	1096	Digital	R 404 A	
VEU 15 SCB	1562x1285x905	40+40	1070	220/50	-	1,43	3/4	15,0	Forzada Forced	2°C/+6°C	Automático Automatic	1315	Digital	R 404 A	
VEU 18 SCB	1875x1285x905	40+40	1310	220/50	-	1,72	1	18,3	Forzada Forced	2°C/+6°C	Automático Automatic	1506	Digital	R 404 A	
VEU 25 SCB	2500x1285x905	40+40	1585	220/50	-	2,29	1+1/6	22,2	Forzada Forced	2°C/+6°C	Automático Automatic	2009	Digital	R 404 A	

Les caractéristiques techniques et la conception peuvent être sujettes à modifications, sans préavis.

VITRINA EXPOSITORA MODULAR FRÍO VENTILADO AUTOSERVICIO SERIE EUROPA
 REFRIGERATED MODULAR SELF SERVICE CASE EUROPE SERIES



VEU 9 SCB

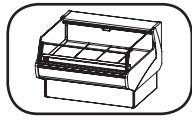

VEU 12 SCB

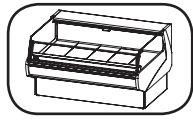

VEU 15 SCB

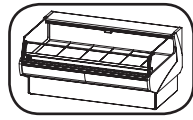

VEU 18 SCB

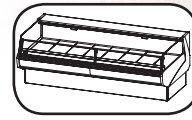

VEU 25 SCB

**NUEVO
NEW**



VEU15SCB

07 V. expositoras

OPCIONES/OPTIONS

Doble plano Double surface	Plano expo Acero Inox Stainless steel exhibition area	Doble plano Inox Double surface inox
(DPEXVEU9S)	(VEU9SCB-1)	(DPEXVEU9S-1)
(DPEXVEU12S)	(VEU12SCB-1)	(DPEXVEU12S-1)
(DPEXVEU15S)	(VEU15SCB-1)	(DPEXVEU15S-1)
(DPEXVEU18S)	(VEU18SCB-1)	(DPEXVEU18S-1)
(DPEXVEU25S)	(VEU25SCB-1)	(DPEXVEU25S-1)

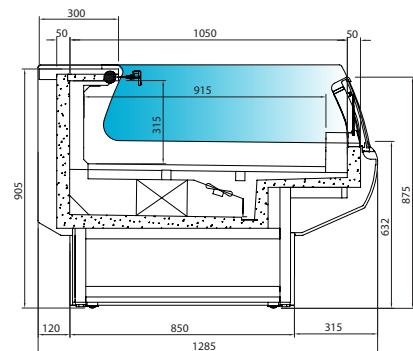

VEU SCB