

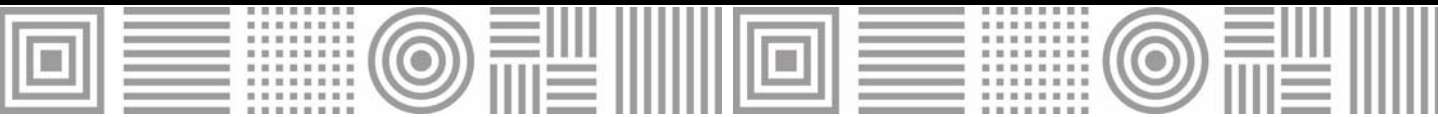

## LSD difusores lineales de ranuras sectorizados



**MADEL®**

Los difusores lineales de la serie **LSD** han sido diseñados para combinar la estética con las prestaciones técnicas. Su montaje se realiza en falsos techos o suspendidos del techo.

Posibilitan la formación de líneas continuas de difusor, con zonas activas e inactivas, sin romper la uniformidad estética del conjunto. Adecuados tanto para la impulsión como para retorno.

Mediante la regulación de sus aletas, orientables individualmente cada 100mm, se puede obtener una distribución horizontal del aire en una u otra dirección o una proyección vertical del mismo sin modificar el volumen del aire.

Los difusores **LSD** admiten una variación de caudal del 60% manteniendo la estabilidad de vena de aire.

Estos difusores pueden ser utilizados en alturas de 2,6 hasta 4 metros y con un diferencial de temperatura de hasta 12°C.

## LSD-AR

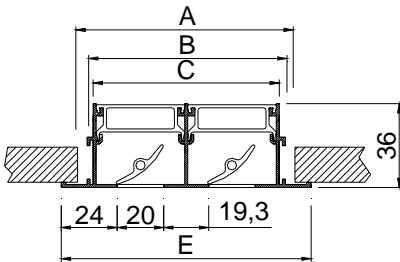

NºVIAS	E	A	B	C
1	68	55	47	40
2	107	95	86	80
3	147	134	125	119
4	186	173	165	159

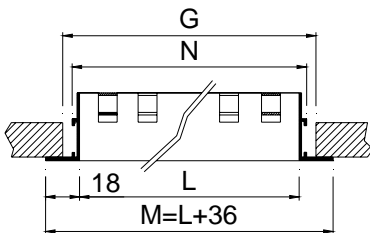

L	M	N	G
500	536	507	516
1000	1036	1007	1016
1200	1236	1207	1216
1500	1536	1507	1516
2000	2036	2007	2016

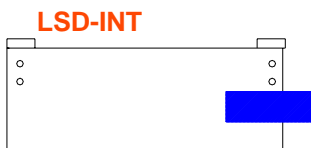

## CLASIFICACIÓN

**LSD-AR** Difusor lineal con ángulos de remate incluidos. Disponible hasta 2m de longitud.

**LSD-ARI** Difusor lineal con un ángulo de remate en el lado izquierdo. Necesario para formar líneas >2m.

**LSD-ARD** Difusor lineal con un ángulo de remate en el lado derecho..Necesario para formar líneas >2m.

**LSD-INT** Difusor lineal sin ángulos de remate. Necesario para formar líneas > 4 m.

## MATERIAL

Difusor construido en aluminio y aletas deflectoras en PVC extruido.

## A90/LSD

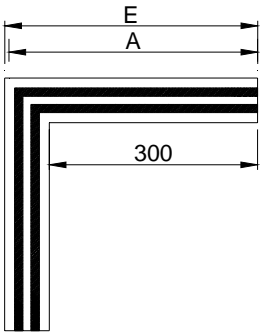

NºVIAS	E	A
1	368	358
2	407	397
3	447	437
4	486	476

## LSD-AR + PLSD...-R

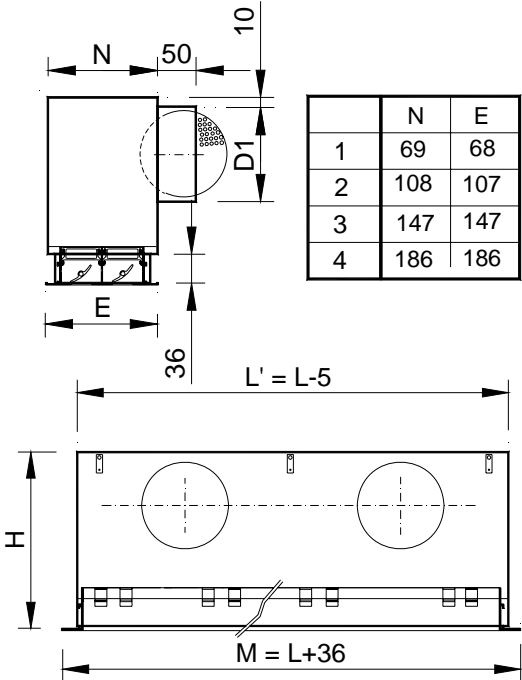

## ACCESORIOS ACOPLABLES

**A90/LSD** Difusor lineal inactivo, formando un ángulo de 90°. Especialmente indicado para instalaciones continuas rectangulares.

**PLSD** Plenum con conexión circular lateral. Incorpora soportes para suspensión en el techo. Construido en acero galvanizado.

**...-R** Plenum con regulador de caudal en el cuello de conexión.

**.../AIS/** Plenum aislado termoacústicamente mediante una espuma con un coeficiente de conductividad térmica de 0,04 w/mk. Dicha espuma cumple con las normas de reacción al fuego:

- UNE 23-727 M2
- NFP 92-501 M2
- DIN 4102 M2

	L < 0,5		L < 1		L < 1,2		L < 1,5		L < 2	
	H	D1	H	D1	H	D1	H	D1	H	D1
1	256	1/158	256	1/158	256	1/158	256	1/158	256	2/158
2	256	1/158	256	1/158	256	1/158	256	2/158	256	2/158
3	296	1/198	296	1/198	296	2/198	296	2/198	296	2/198
4	296	1/198	296	1/198	296	2/198	296	2/198	296	2/198

## SISTEMAS DE FIJACIÓN

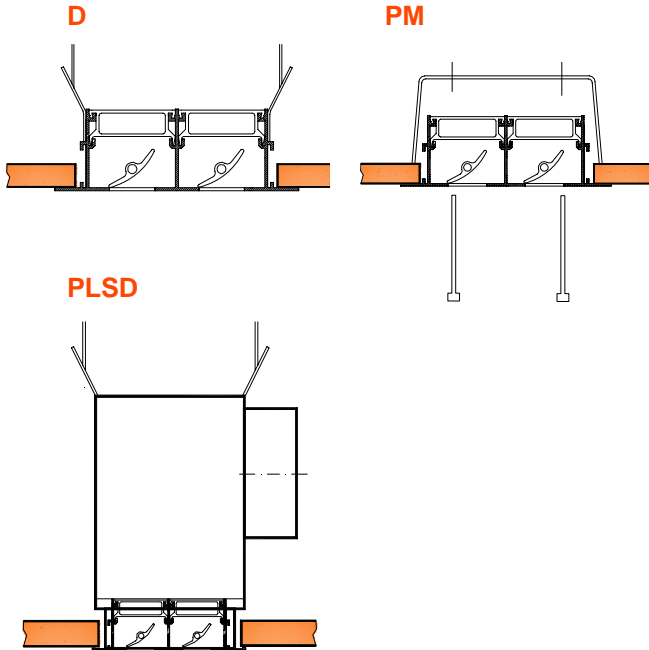

**D** Escuadras para suspensión del difusor **LSD** al techo mediante varillas (standard)

**PM** Puentes de montaje con tornillos, para fijación del difusor sin plenum **LSD** en instalaciones con falso techo y conducto rectangular. Construidos en acero galvanizado.

**PLSD** Escuadras para suspensión del conjunto difusor + plenum **LSD+PLSD** al techo mediante varillas (standard)

**(PL)** Fijación del difusor **LSD** al plenum **PLSD+PML** mediante clips y suspensión del conjunto al techo mediante varillas. Este sistema facilita y simplifica el montaje y desmontaje del difusor al plenum.

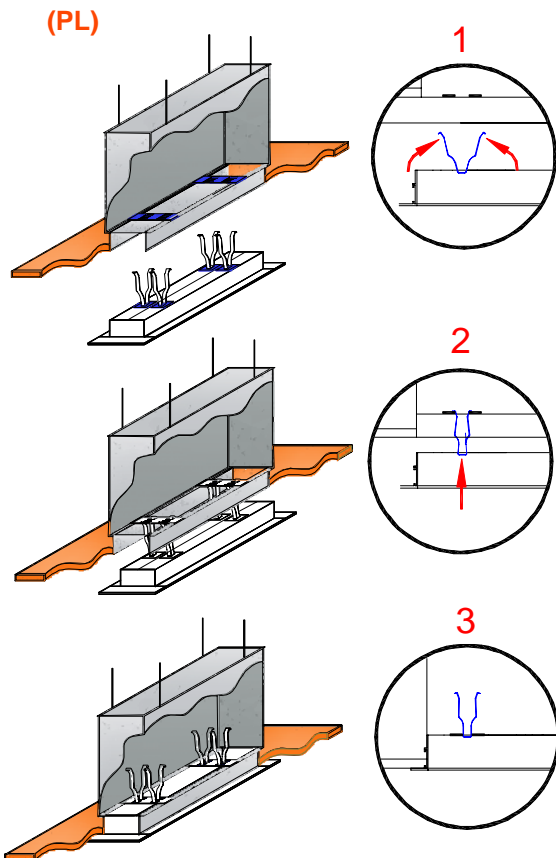

## LSD

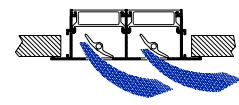

VELOCIDAD RECOMENDADAS.

VIAS	Vmin (m/s)	Vmax (m/s)
1	2.5	4.5
2	2.5	4.5
3	2.5	4
4	2.5	4

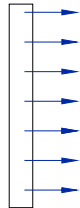

VELOCIDAD LIBRE, PERDIDA DE CARGA Y POTENCIA SONORA.  
ALCANCE CON EFECTO TECHO: 1 DIRECCIÓN.  
LSD-AR + PLSD

SECCION LIBRE DE SALIDA DEL AIRE (m<sup>2</sup>).

	0.5 m	1 m	1.5 m	2 m
1	0.0043	0.0087	0.013	0.0174
2	0.0087	0.0174	0.0261	0.0348
3	0.013	0.0261	0.0391	0.0522
4	0.0172	0.0348	0.052	0.0696

VALORES DE CORRECCION PARA Dpt Y Lwa1.  
LSD-AR + PLSD-R

		0.5 m			1 m			1.5 m			2 m		
		100%	50%	0%	100%	50%	0%	100%	50%	0%	100%	50%	0%
1	Dpt	0.95	2.35	3.15	1	1.4	2.2	1	1.4	2.2	1.1	2.5	3.3
	Lwa1	-6	-3	-3,6	0	0,8	0,4	+1,2	+1,9	+1,4	-2	-	-1,6
2	Dpt	0.98	2.48	3.25	1	1.5	2.3	1	1.5	2.3	1.2	2.7	3.5
	Lwa1	-4	-3,6	-3,1	0	+0,6	+0,6	+2,3	+3,2	+3,1	0	+1	+1,2
3	Dpt	0.96	2.26	3.36	1	1.3	2.4	1	1.3	2.4	1.3	2.4	3.5
	Lwa1	-7	-6	-6	0	+0,9	+0,5	-2,7	-2,6	-2,7	-1,4	-1,1	-1,1
4	Dpt	0.95	2.35	3.05	1	1.4	2.1	1	1.4	2.1	1.1	2.5	3.2
	Lwa1	-3,4	-1,4	-2,5	0	+1,5	+1,2	-1,8	-1,1	-1,2	-1,7	-1	-1,1

$$Dpt1 = Kp \times Dpt$$

$$Lwa1 = Lwa + Kf$$

FACTOR DE CORRECCION DEL  
ALCANCE KL

	0.5 m	1 m	1.5 m	2 m
1	0.71	1	1.07	1.14
2	0.73	1	1.09	1.15
3	0.74	1	1.11	1.2
4	0.75	1	1.25	1.25

$$AL'02 = Kl \times AL02$$

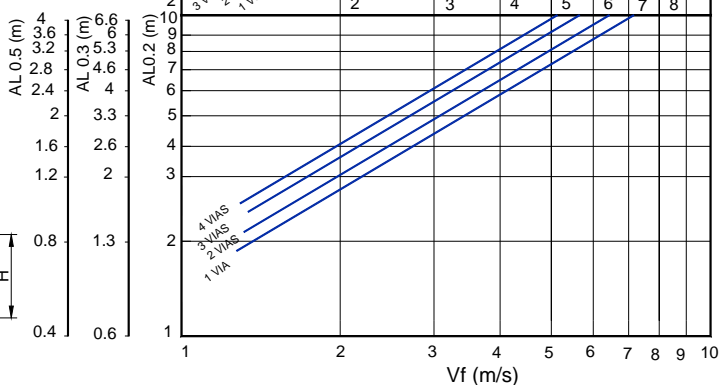
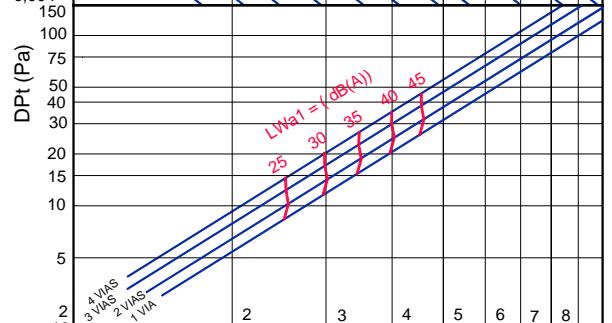
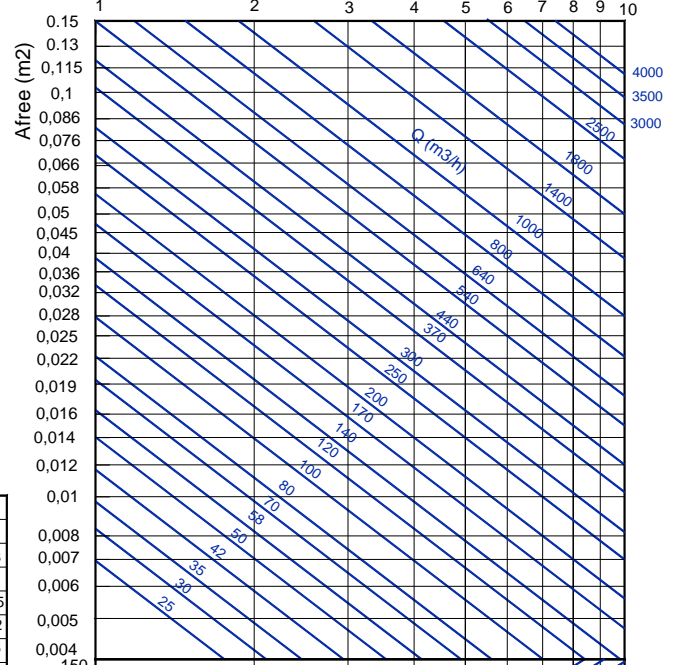
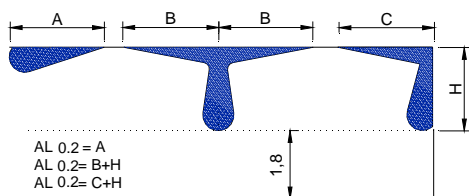

Nota: En MadelMedia Espectro por banda de octava en Hz.



**LSD**

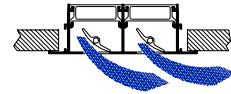

FACTOR DE CORRECCION DE LA DIFUSION VERTICAL (bv) PARA DT (-).

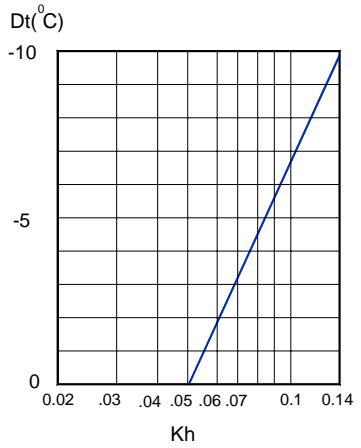

Kh = Factor de corrección de la difusión vertical.

FACTOR DE CORRECCION DEL ALCANCE (L0.2) DT (-).

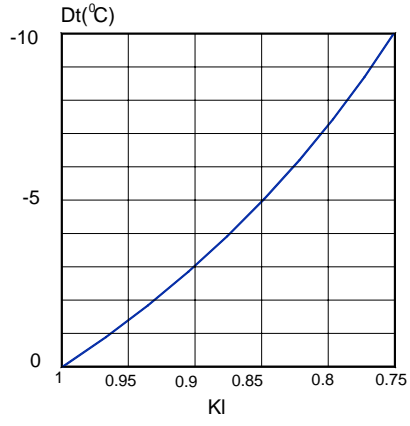

Kl = Factor de corrección del alcance.

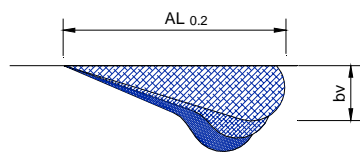

$$bv = Kh \times AL_{0.2}$$

$$AL'_{0.2} (Dt < 0) = Kl \times AL_{0.2}$$

RELACION DE TEMPERATURAS.

$$\frac{Dt_l}{Dt_z} = \frac{t_{local} - t_x}{t_{local} - t_{imp}}$$

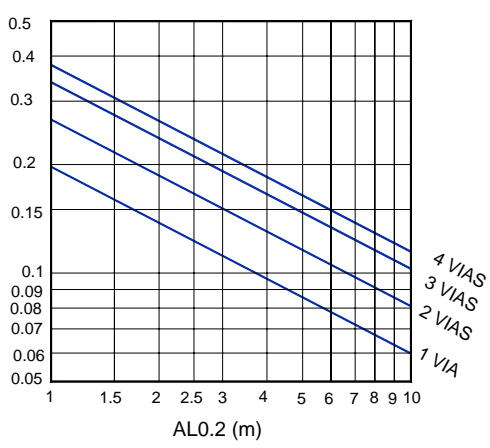

RELACION DE INDUCCION.

$$i = \frac{Q_r}{Q_0} = \frac{Q_{total\ en\ x}}{Q_{de\ impulsión}}$$

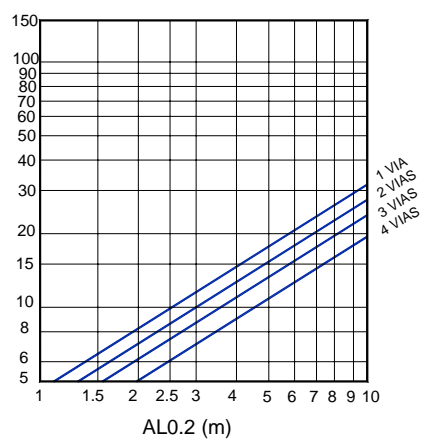

## LSD

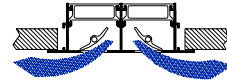

VELOCIDAD RECOMENDADAS.

VIAS	Vmin (m/s)	Vmax (m/s)
2	2.5	4.5
4	2.5	4

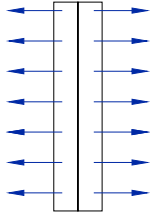

SECCION LIBRE DE SALIDA DELAIRE (m2).

	0.5 m	1 m	1.5 m	2 m
1	0.0043	0.0087	0.013	0.0174
2	0.0087	0.0174	0.0261	0.0348
3	0.013	0.0261	0.0391	0.0522
4	0.0172	0.0348	0.052	0.0696

VALORES DE CORRECCION PARA DPT Y Lwa1.

	0.5 m			1 m			1.5 m			2 m			
	100%	50%	0%	100%	50%	0%	100%	50%	0%	100%	50%	0%	
2	Dpt	0.98	2.48	3.25	1	1.5	2.3	1	1.5	2.3	1.2	2.7	3.5
	Lwa1	-3,9	-3,5	-3	0	+0,6	+0,6	+2,3	+3,2	+3,1	-0,3	+0,9	+1,1
4	Dpt	0.95	2.35	3.05	1	1.4	2.1	1	1.4	2.1	1.1	2.5	3.2
	Lwa1	-3,6	-1,5	-2,5	0	+1,5	+1,1	-1,5	-1,3	-1,4	-1,8	-1,2	-1,3

$$DPT1 = Kp \times DPT$$

$$Lwa1 = Lwa + Kf$$

FACTOR DE CORRECCION DEL ALCANCE KL

	0.5 m	1 m	1.5 m	2 m
2	0,6	1	1,17	1,3
4	0,767	1	1,2	1,17

$$AL'02 = KI \times AL02$$

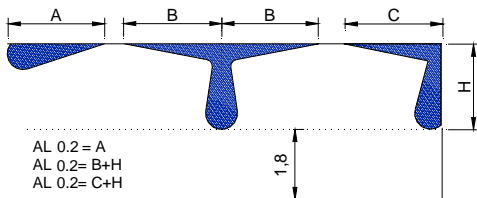

VELOCIDAD LIBRE, PERDIDA DE CARGA Y POTENCIA SONORA, ALCANCE CON EFECTO TECHO: 2 DIRECCIONES.

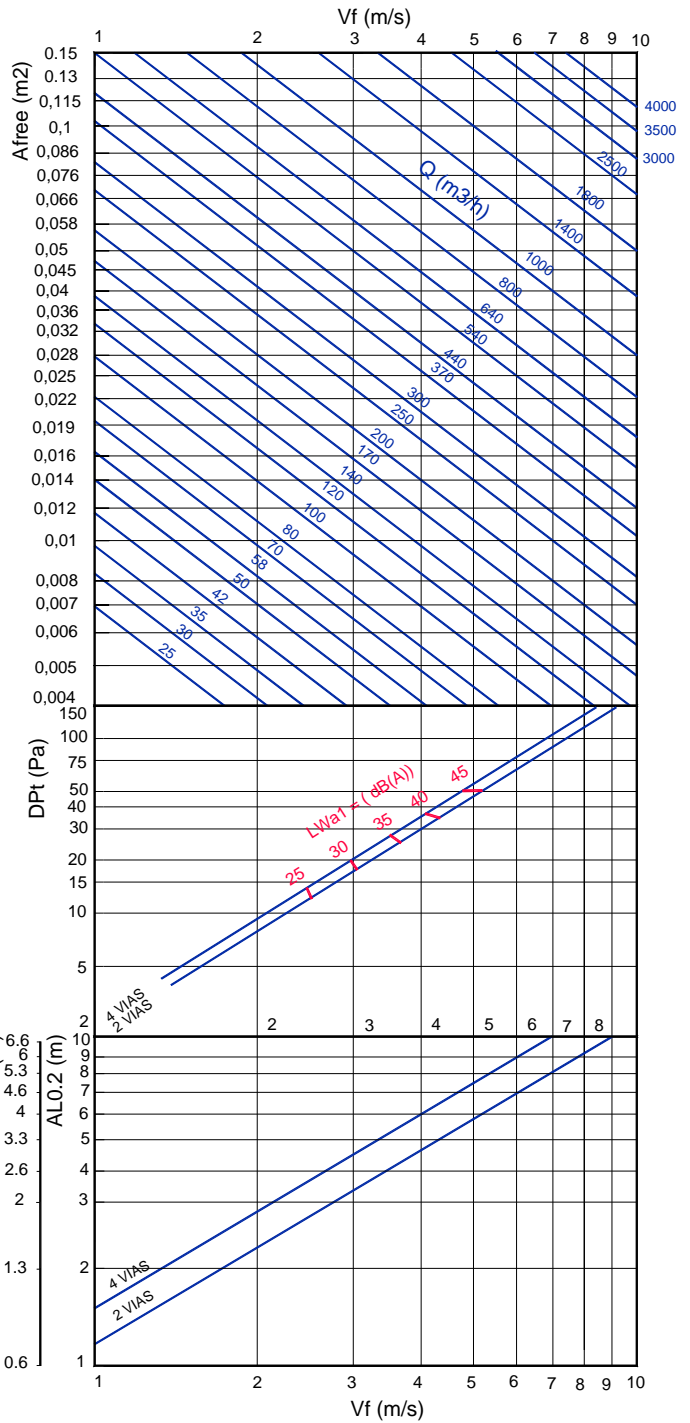

Nota: En MadelMedia Espectro por banda de octava en Hz.



LSD

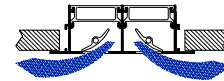

FACTOR DE CORRECCION DE LA DIFUSION VERTICAL (bv) PARA DT (-).

FACTOR DE CORRECCION DEL ALCANCE (L0.2) DT (-).

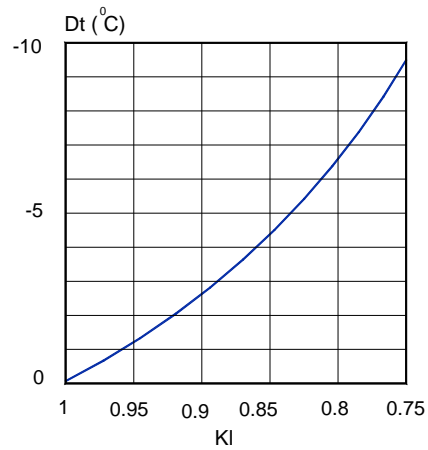
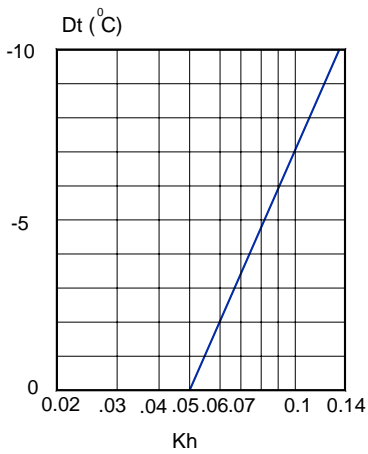

Kh = Factor de corrección de la difusión vertical.

kl = Factor de corrección del alcance.

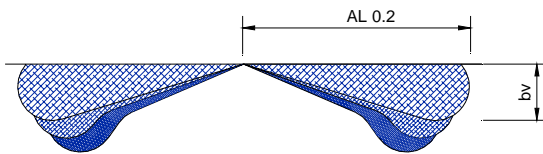

$$bv = Kh \times Al_{0.2}$$

$$AL'_{0.2} (Dt < 0) = Kl \times AL_{0.2}$$

RELACION DE TEMPERATURAS.

RELACION DE INDUCCION.

$$\frac{Dtl}{Dtz} = \frac{t_{local} - t_x}{t_{local} - t_{imp}}$$

$$i = \frac{Q_r}{Q_0} = \frac{Q_{total\ en\ x}}{Q_{de\ impulsión}}$$

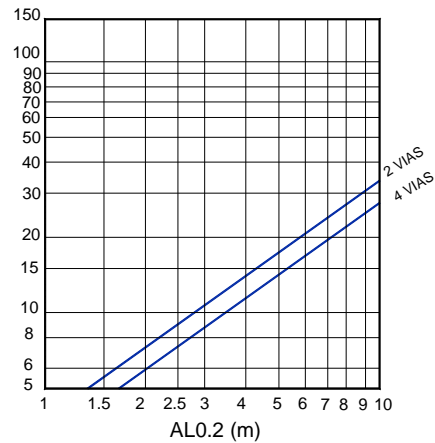
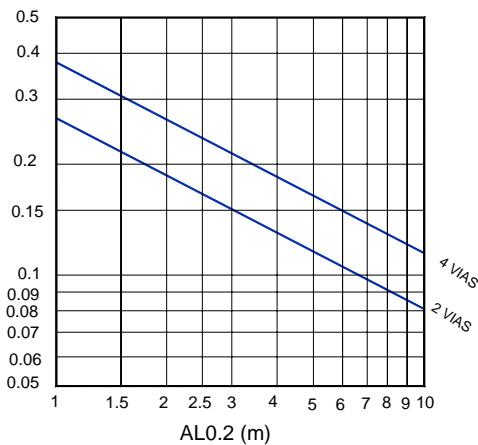



## LSD

VELOCIDAD RECOMENDADAS.

VIAS	Vmin (m/s)	Vmax (m/s)
1	2.5	4.5
2	2.5	4.5
3	2.5	4
4	2.5	4

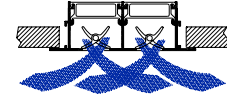
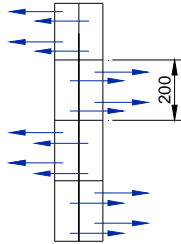

VELOCIDAD LIBRE, PERDIDA DE CARGA Y POTENCIA SONORA, ALCANCE CON EFECTO TECHO: 2 DIRECCIONES.

SECCION LIBRE DE SALIDA DEL AIRE (m2).

	0.5 m	1 m	1.5 m	2 m
1	0.0043	0.0087	0.013	0.0174
2	0.0087	0.0174	0.0261	0.0348
3	0.013	0.0261	0.0391	0.0522
4	0.0172	0.0348	0.052	0.0696

VALORES DE CORRECCION PARA Dpt Y Lwa1.

	0.5 m			1 m			1.5 m			2 m			
	100%	50%	0%	100%	50%	0%	100%	50%	0%	100%	50%	0%	
1	Dpt	0.95	2.35	3.15	1	1.4	2.2	1	1.4	2.2	1.1	2.5	3.3
	Lwa1	-6	-3	-3.7	0	+0.8	+0.4	+1	+1.7	+1.2	-2.1	-0.4	-1.9
2	Dpt	0.98	2.48	3.25	1	1.5	2.3	1	1.5	2.3	1.2	2.7	3.5
	Lwa1	-3.7	-3.4	-2.9	0	+0.6	+0.6	+2.4	+3.3	+3.2	-0.5	+0.8	+0.9
3	Dpt	0.96	2.26	3.36	1	1.3	2.4	1	1.3	2.4	1.3	2.4	3.5
	Lwa1	-6.9	-6.3	-5.9	0	+0.9	+0.5	-3	-2.9	-3	-1.8	-1.5	-1.6
4	Dpt	0.95	2.35	3.05	1	1.4	2.1	-3	-2.9	-3	1.1	2.5	3.2
	Lwa1	-3.4	-1.6	-2.4	0	+1.6	+1.2	-2	-1.4	-1.5	-2	-1.3	-1.5

$$Dpt1 = Kp \times Dpt$$

$$Lwa1 = Lwa + Kf$$

FACTOR DE CORRECCION DEL ALCANCE KL

	0.5 m	1 m	1.5 m	2 m
1	0.82	1	1.2	1.43
2	0.73	1	1.27	1.34
3	0.8	1	1.17	1.22
4	0.9	1	1.14	1.19

$$AL'02 = Kl \times AL02$$

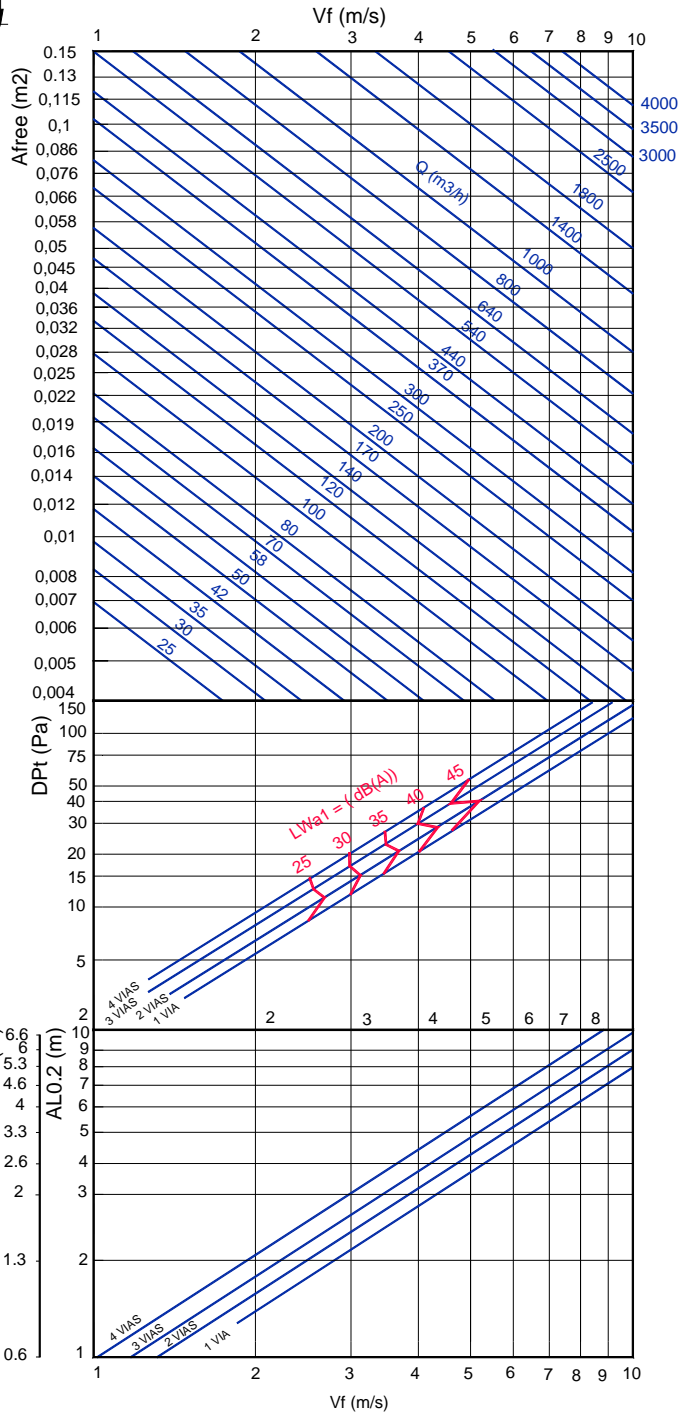
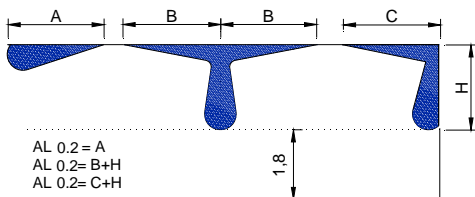

Nota: En MadelMedia Espectro por banda de octava en Hz.

LSD

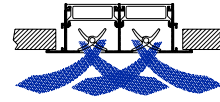

FACTOR DE CORRECCION DE LA DIFUSION VERTICAL (bv) PARA DT (-).

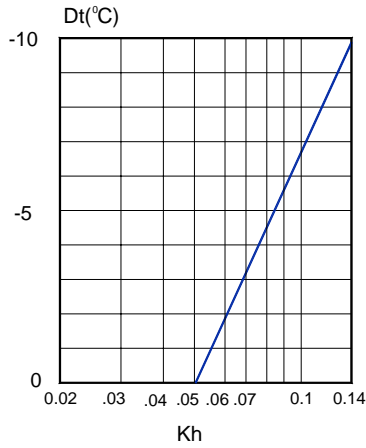

Kh = Factor de corrección de la difusión vertical.

FACTOR DE CORRECCION DEL ALCANCE (L0.2) DT (-).

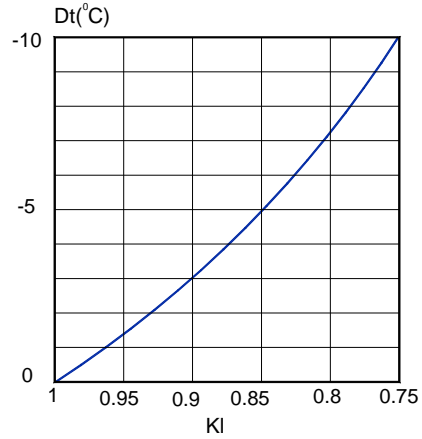

Kl = Factor de corrección del alcance.

$$bv = Kh \times Al_{0.2}$$

$$AL'_{0.2} (Dt < 0) = Kl \times AL_{0.2}$$

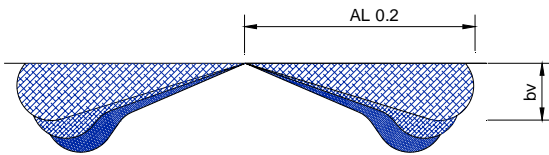

RELACION DE TEMPERATURAS.

$$\frac{Dtl}{Dtz} = \frac{t \text{ local} - t_x}{t \text{ local} - t_{imp}}$$

RELACION DE INDUCCION.

$$i = \frac{Q_r}{Q_0} = \frac{Q \text{ total en } x}{Q \text{ de impulsión}}$$

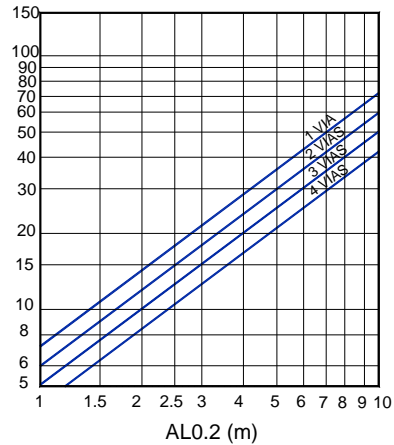
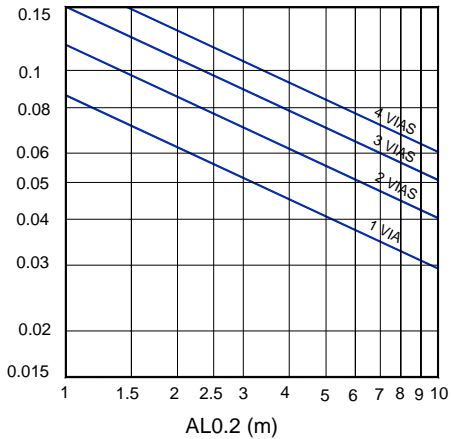

## LSD

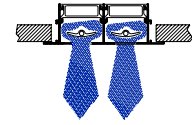

VELOCIDAD RECOMENDADAS.

VIAS	Vmin (m/s)	Vmax (m/s)
1	2.5	4.5
2	2.5	4.5
3	2.5	4
4	2.5	4

VELOCIDAD LIBRE, PERDIDA DE CARGA Y POTENCIA SONORA:  
IMPULSION VERTICAL.

SECCION LIBRE DE SALIDA DEL AIRE (m2).

	0.5 m	1 m	1.5 m	2 m
1	0.0043	0.0087	0.013	0.0174
2	0.0087	0.0174	0.0261	0.0348
3	0.013	0.0261	0.0391	0.0522
4	0.0172	0.0348	0.052	0.0696

VALORES DE CORRECCION PARA Dpt Y Lwa1.

		0.5 m			1 m			1.5 m			2 m		
		100%	50%	0%	100%	50%	0%	100%	50%	0%	100%	50%	0%
1	Dpt	0.95	2.35	3.15	1	1.4	2.2	1	1.4	2.2	1.1	2.5	3.3
	Lwa1	-6.1	-3.1	-3.6	0	+0.8	+0.4	+0.9	+1.6	+1	-2.1	-0.5	-1.9
2	Dpt	0.98	2.48	3.25	1	1.5	2.3	1	1.5	2.3	1.2	2.7	3.5
	Lwa1	-3.8	-3.4	-2.9	0	+0.6	+0.6	+2.4	+3.3	+3.2	-0.3	+0.9	+1.1
3	Dpt	0.96	2.26	3.36	1	1.3	2.4	1	1.3	2.4	1.3	2.4	3.5
	Lwa1	-7	-6.3	-6	0	+0.9	+0.5	-2.8	-2.8	-2.9	-1.5	-1.2	-1.3
4	Dpt	0.95	2.35	3.05	1	1.4	2.1	1	1.4	2.1	1.1	2.5	3.2
	Lwa1	-3.4	-1.5	-2.5	0	+1.6	+1.2	-1.9	-1.3	-1.4	-1.9	-1.2	-1.3

$$Dpt1 = Kp \times Dpt$$

$$Lwa1 = Lwa + Kf$$

FACTOR DE CORRECCION DEL  
ALCANCE KL

	0.5 m	1 m	1.5 m	2 m
1	0.7	1	1.1	1.2
2	0.72	1	1.15	1.25
3	0.72	1	1.12	1.2
4	0.74	1	1.25	1.25

$$ALv'0.2 = Kl \times ALv0.2$$

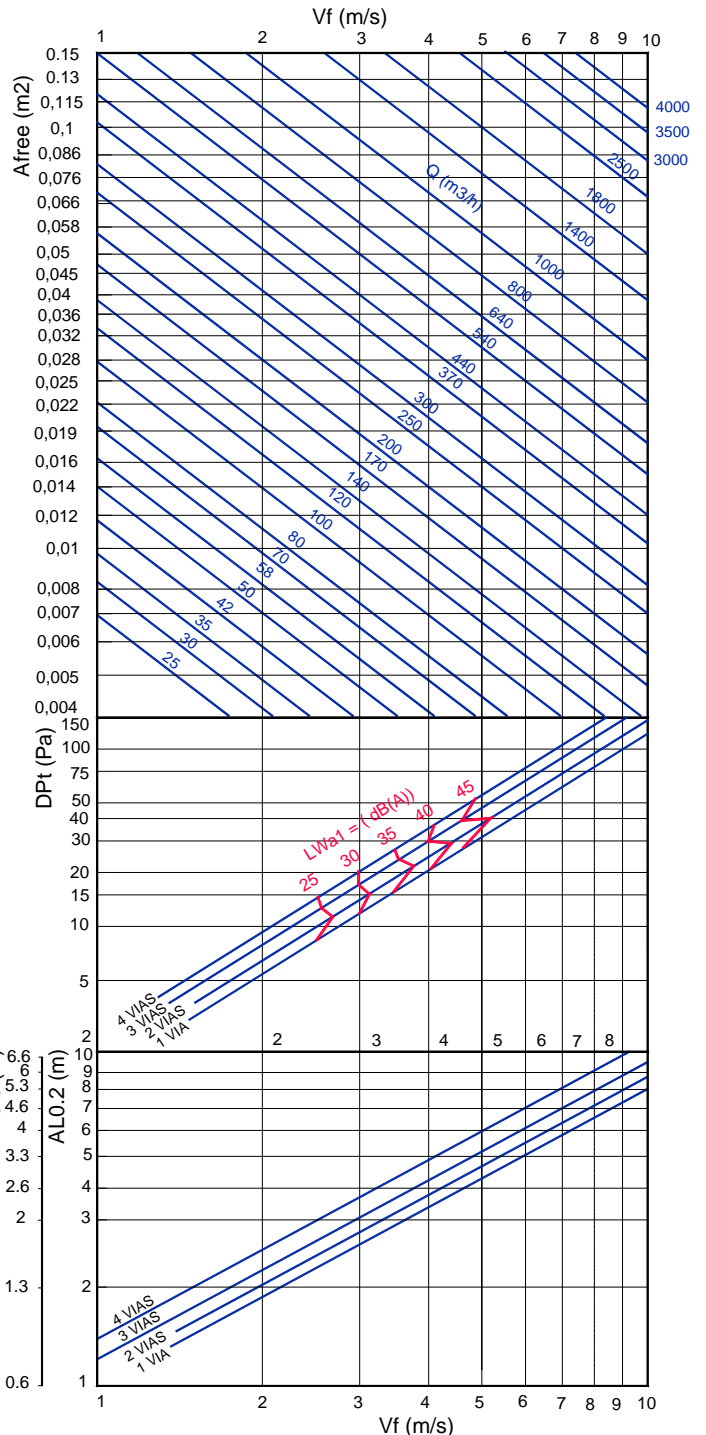
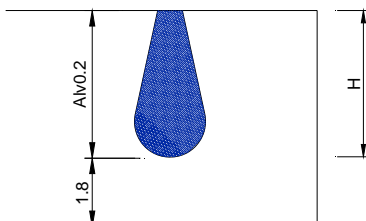

Nota: En MadelMedia Espectro por banda de octava en Hz.

## LSD

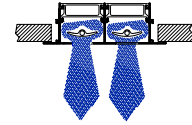

FACTOR DE CORRECCION DEL ALCANCE VERTICAL (Alv 0,2) DT(+).

	D T(+5)	DT(+10)
1 VIA	0.75	0.64
2 VIAS	0.76	0.65
3 VIAS	0.77	0.66
4 VIAS	0.8	0.64

DT = T impulsión - T ocal.

EJEMPLO:

LSD 2VIAS x 2m

Afree = 0.0348 m<sup>2</sup>.

Vf = 3.1 m/s.

ALv 0,2 = 2.9 m.

ALv'02 = 1.1 x 2.9 = 3.19 m.

DT(+5) = 0.76 x 3.19 = 2.42 m.

DT (+10) = 0.65 x 3.19 = 2.07m.

Alv 0,2 (DT +) = Kv x Al 02

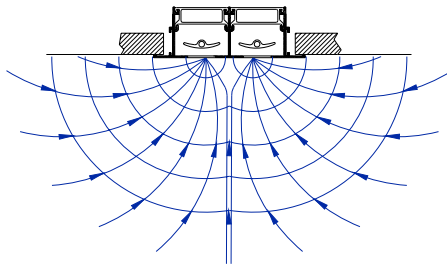

VELOCIDAD RECOMENDADAS.

VIAS	Vmin (m/s)	Vmax (m/s)
1	2	3.5
2	2	3.5
3	2	3
4	2	3

SECCION LIBRE DE SALIDA DEL AIRE (m<sup>2</sup>).

	0.5 m	1 m	1.5 m	2 m
1	0.0043	0.0087	0.013	0.0174
2	0.0087	0.0174	0.0261	0.0348
3	0.013	0.0261	0.0391	0.0522
4	0.0172	0.0348	0.052	0.0696

VALORES DE CORRECCION PARA Dpt Y Lwa1.

		0.5 m			1 m			1.5 m			2 m		
		100%	50%	0%	100%	50%	0%	100%	50%	0%	100%	50%	0%
1	Dpt	0.88	2.28	3	1	1.4	2.2	1.3	2.7	3.5	1.5	2.9	3.7
	Lwa1	-	3	5	-	4	7	-	3	5	-	3	7
2	Dpt	0.85	2.35	3.15	1	1.5	2.3	1.4	2.9	3.7	1.66	3.16	3.96
	Lwa1	-	3	5	-	4	7	-	4	7	-	3	8
3	Dpt	0.8	2.1	3.2	1	1.3	2.4	1.2	2.5	3.6	1.4	2.7	3.8
	Lwa1	-	4	5	-	5	8	-	5	8	-	4	8
4	Dpt	0.7	2.1	2.8	1	1.4	2.1	1.3	2.7	3.4	1.5	2.9	3.6
	Lwa1	-	4	5	-	4	8	-	5	8	-	4	8

$$Dpt1 = Kp \times Dpt$$

$$Lwa1 = Lwa + Kf$$

VELOCIDAD LIBRE, PERDIDA DE CARGA Y POTENCIA SONORA.

